

PTFB213004F

High Power RF LDMOS Field Effect Transistor 300 W, 2110 – 2170 MHz

Description

The PTFB213004F is a 300-watt LDMOS FET designed for class AB operation in cellular amplifiers covering the 2110 to 2170 MHz frequency band. Features include high peak power, input and output match, and a thermally-enhanced, open-cavity earless ceramic package.

PTFB213004F
Package H-37275-6/2

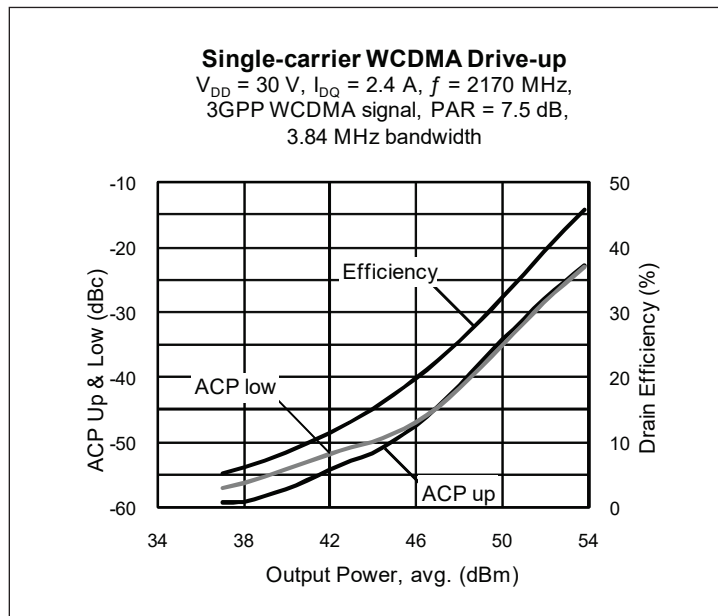
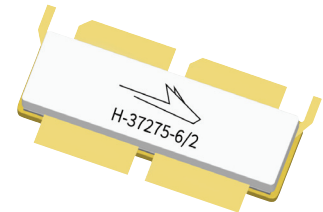

Features

- Broadband internal matching
- Enhanced for use in DPD error correction systems
- Wide video bandwidth
- Typical single-carrier WCDMA performance at 2170 MHz, 30 V
 - $P_{OUT} = 49.5\text{ dBm Avg}$
 - Gain = 17.5 dB
 - Efficiency = 30%
- Increased negative gate-source voltage range for improved performance in Doherty amplifiers
- Capable of handling 10:1 VSWR @ 30 V, 300 W (CW) output power
- Excellent thermal stability
- Integrated ESD protection
- Pb-free and RoHS-compliant

RF Characteristics

Two-carrier WCDMA Measurements (tested in Wolfspeed test fixture)

$V_{DD} = 30\text{ V}$, $I_{DQ} = 2.4\text{ A}$, $P_{OUT} = 60\text{ W average}$,
 $f_1 = 2167.5\text{ MHz}$, $f_2 = 2172.5\text{ MHz}$, 3GPP signal, channel bandwidth = 3.84 MHz, PAR = 7.5 dB @ 0.01% CCDF

Characteristic	Symbol	Min	Typ	Max	Unit
Gain	G_{ps}	17	18	—	dB
Drain Efficiency	η_D	25	26.5	—	%
Intermodulation Distortion	IMD	—	-36	-33	dBc

All published data at $T_{CASE} = 25^\circ\text{C}$ unless otherwise indicated

ESD: Electrostatic discharge sensitive device—observe handling precautions!

RF Characteristics (cont.)

Two-tone Measurements (not subject to production test—verified by design / characterization in WolfSpeed test fixture)
 $V_{DD} = 30\text{ V}$, $I_{DQ} = 2.4\text{ A}$, $P_{OUT} = 250\text{ W PEP}$, $f = 2140\text{ MHz}$, tone spacing = 1 MHz

Characteristic	Symbol	Min	Typ	Max	Unit
Gain	G_{ps}	—	18	—	dB
Drain Efficiency	η_D	—	37	—	%
Intermodulation Distortion	IMD	—	-30	—	dBc

DC Characteristics

Characteristic	Conditions	Symbol	Min	Typ	Max	Unit
Drain-Source Breakdown Voltage	$V_{GS} = 0\text{ V}$, $I_{DS} = 10\text{ }\mu\text{A}$	$V_{(BR)DSS}$	65	—	—	V
Drain Leakage Current	$V_{DS} = 30\text{ V}$, $V_{GS} = 0\text{ V}$	I_{DSS}	—	—	1.0	μA
	$V_{DS} = 63\text{ V}$, $V_{GS} = 0\text{ V}$	I_{DSS}	—	—	10.0	μA
On-State Resistance	$V_{GS} = 10\text{ V}$, $V_{DS} = 0.1\text{ A}$	$R_{DS(on)}$	—	0.03	—	Ω
Operating Gate Voltage	$V_{DS} = 30\text{ V}$, $I_{DQ} = 2.4\text{ A}$	V_{GS}	2.3	2.8	3.3	V
Gate Leakage Current	$V_{GS} = 10\text{ V}$, $V_{DS} = 0\text{ V}$	I_{GSS}	—	—	1.0	μA

Maximum Ratings

Parameter	Symbol	Value	Unit
Drain-Source Voltage	V_{DSS}	-0.5 to +65	V
Gate-Source Voltage	V_{GS}	-6 to +10	V
Junction Temperature	T_J	200	$^{\circ}\text{C}$
Storage Temperature Range	T_{STG}	-40 to +150	$^{\circ}\text{C}$
Thermal Resistance ($T_{CASE} = 70^{\circ}\text{C}$)	$R_{\theta JC}$	0.23	$^{\circ}\text{C/W}$

Ordering Information

Type and Version	Order Code	Package Description	Shipping
PTFB213004F V2 R0	PTFB213004F-V2-R0	H-37275-6/2, earless flange	Tape & Reel, 50 pcs
PTFB213004F V2 R250	PTFB213004F-V2-R250	H-37275-6/2, earless flange	Tape & Reel, 250 pcs

Typical Performance (data taken in a production test fixture)

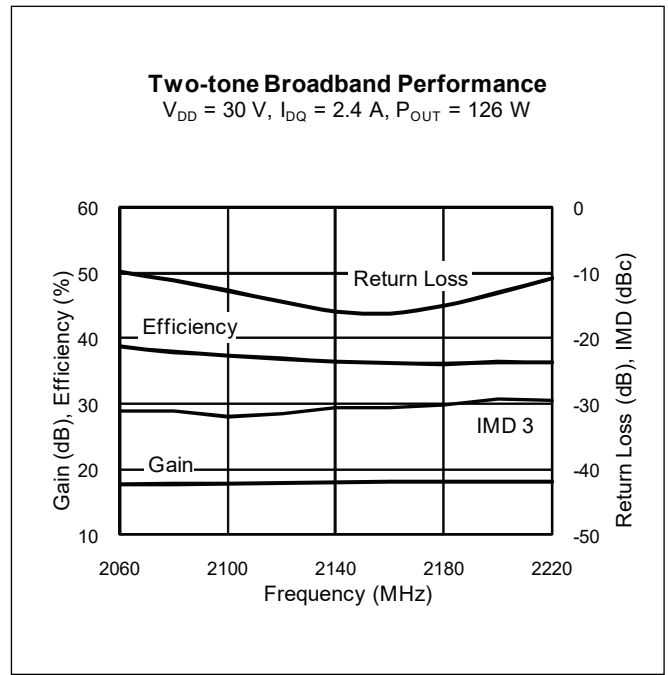
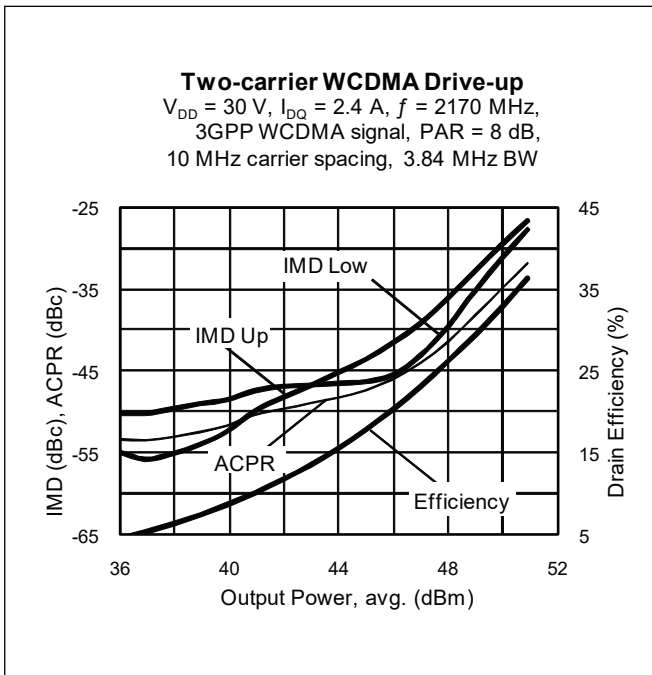
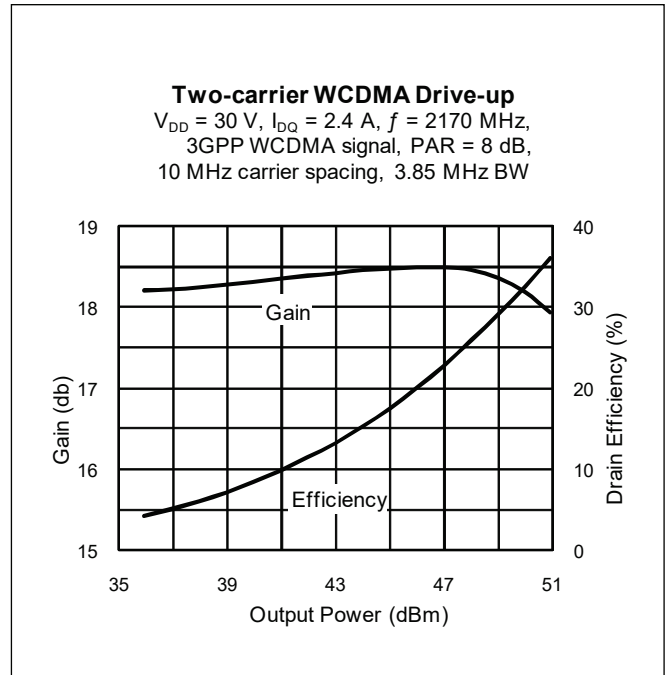
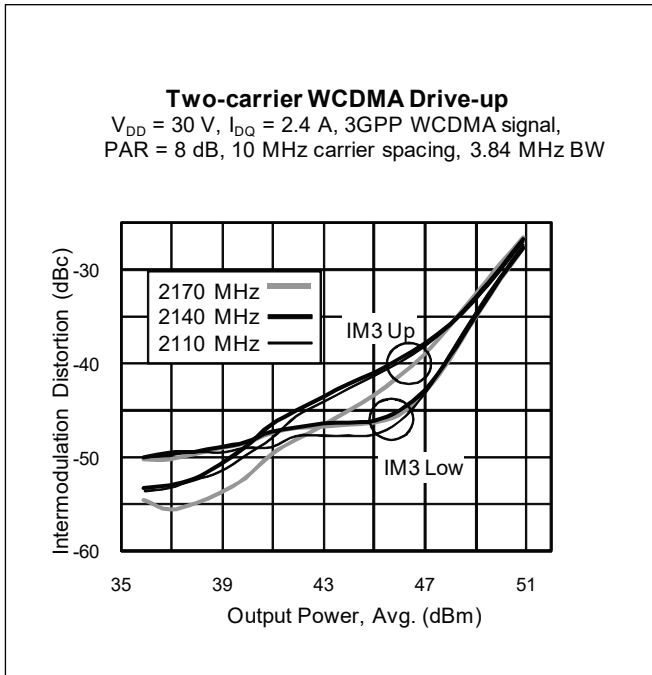



Typical Performance (cont.)

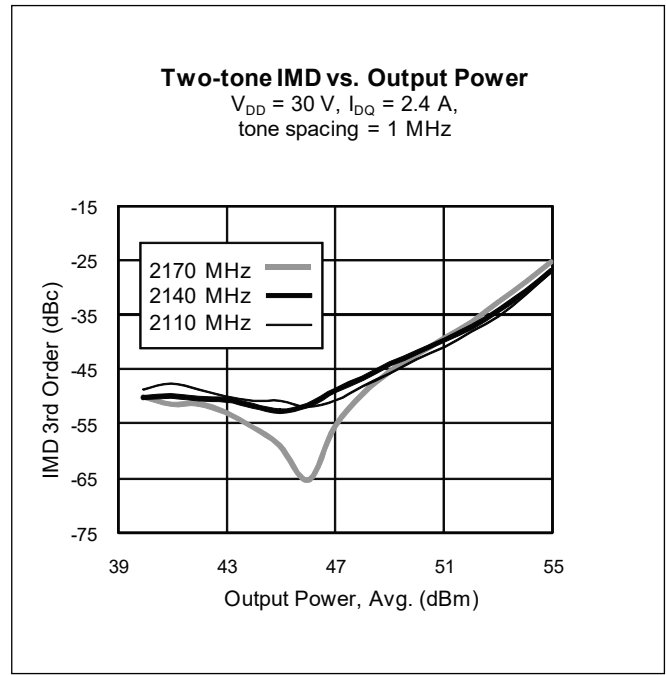
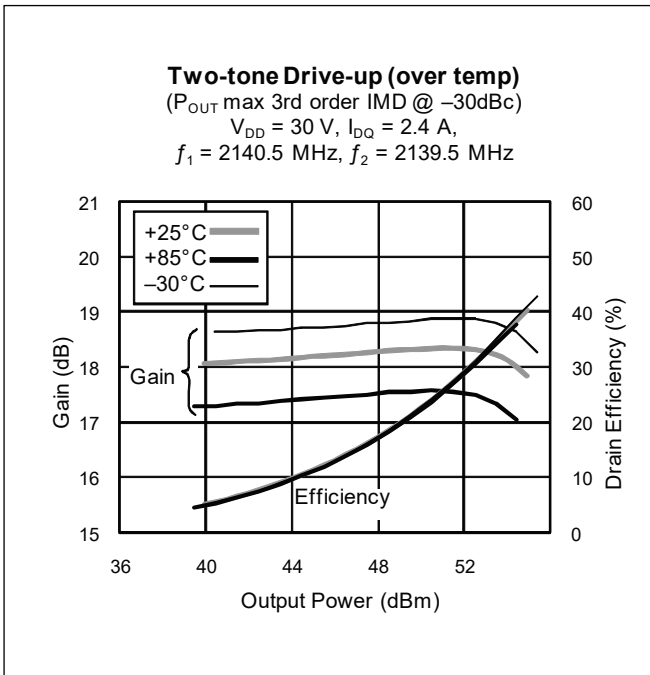
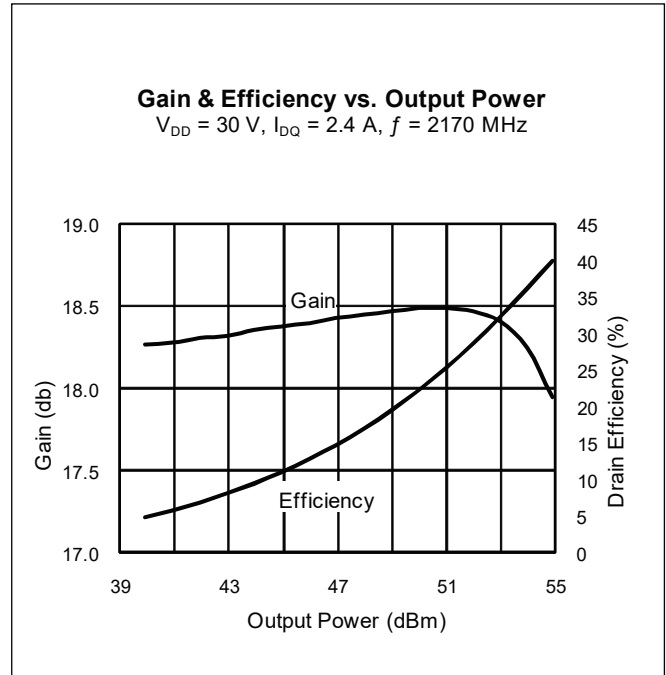
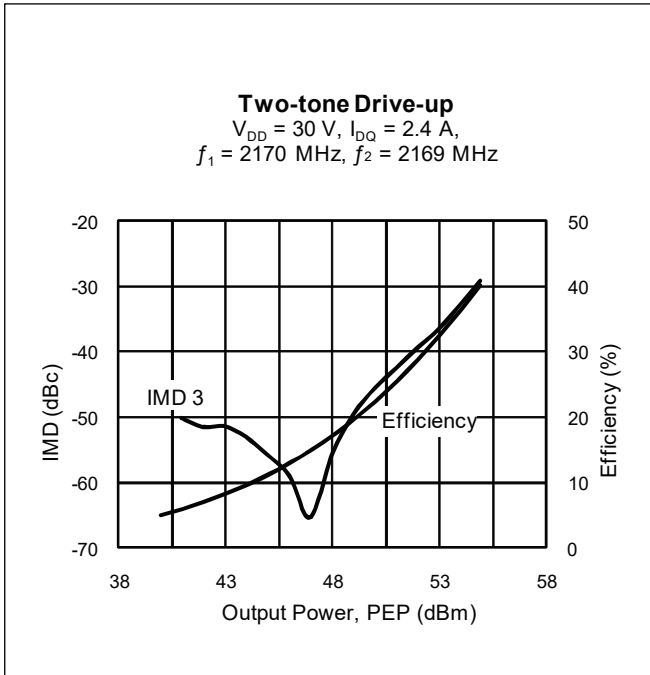

Typical Performance (cont.)

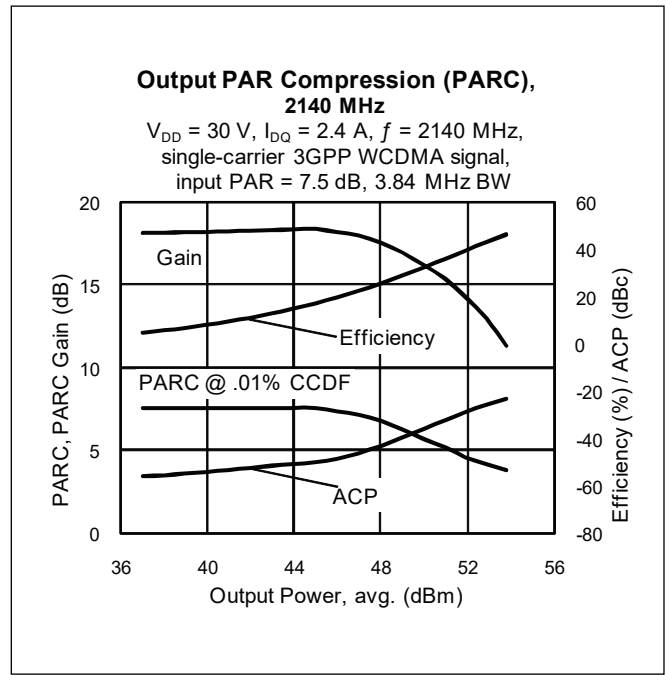
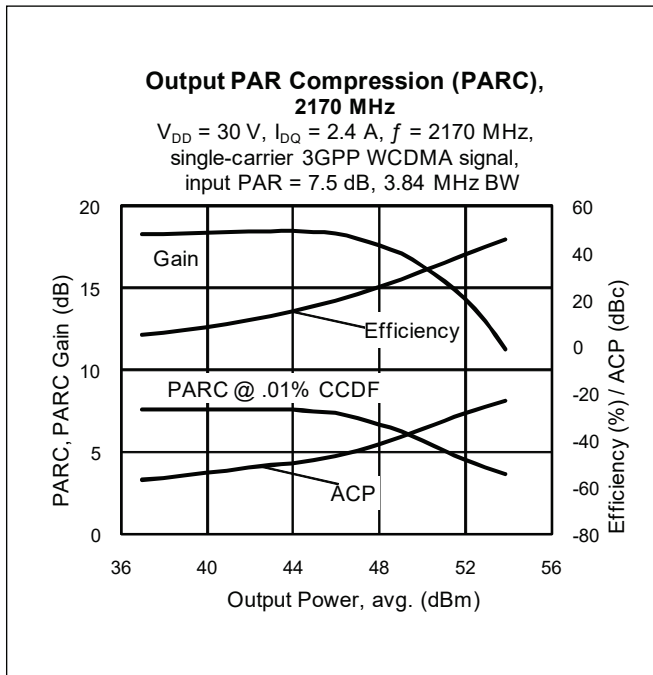
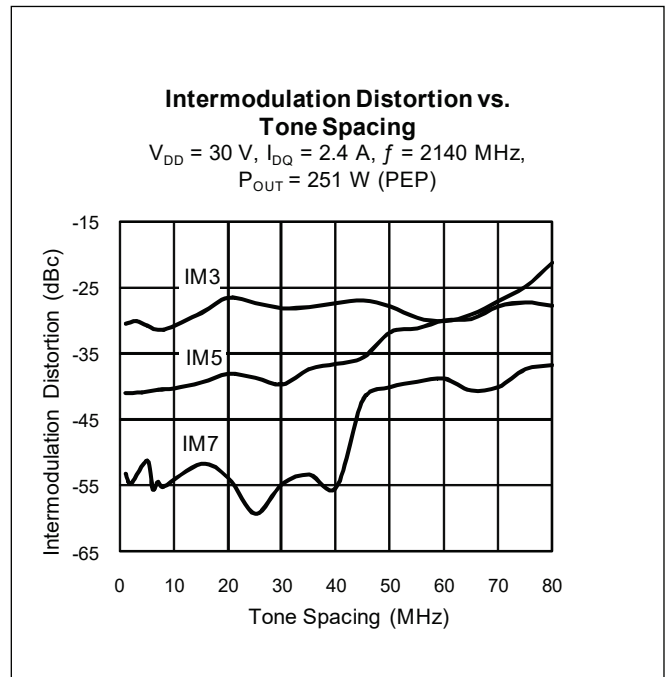
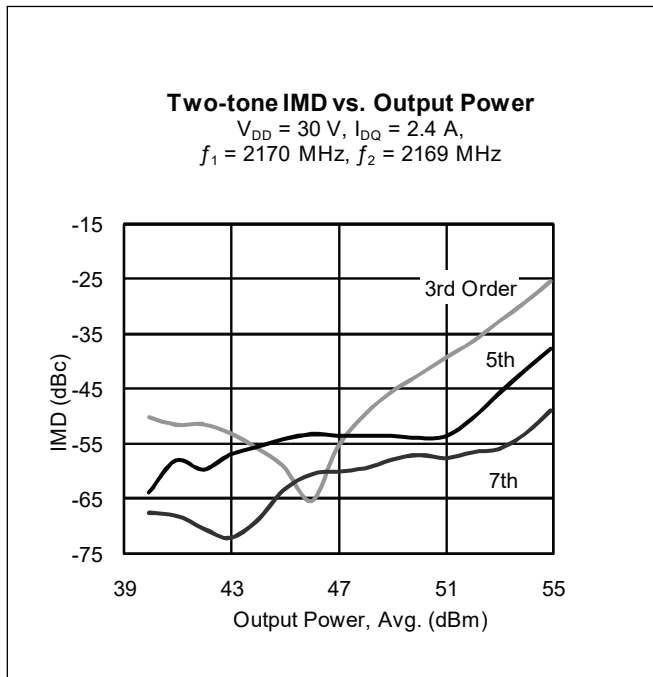

Typical Performance (cont.)

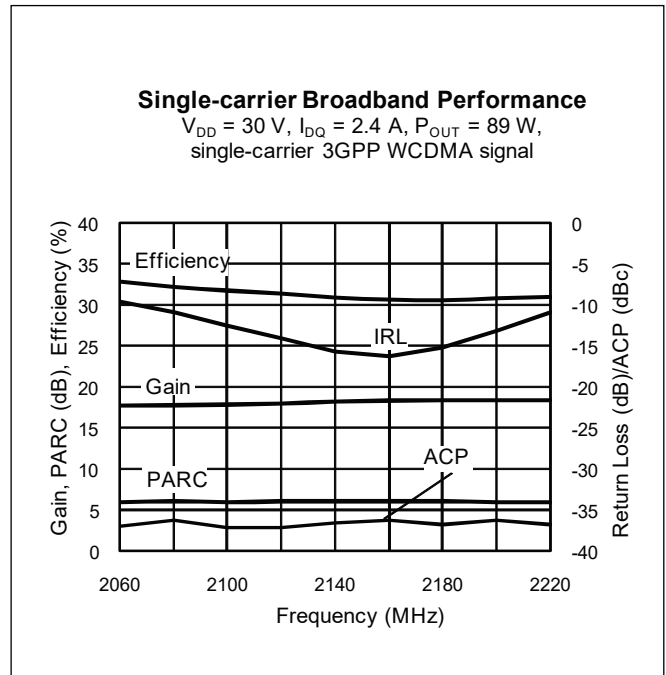
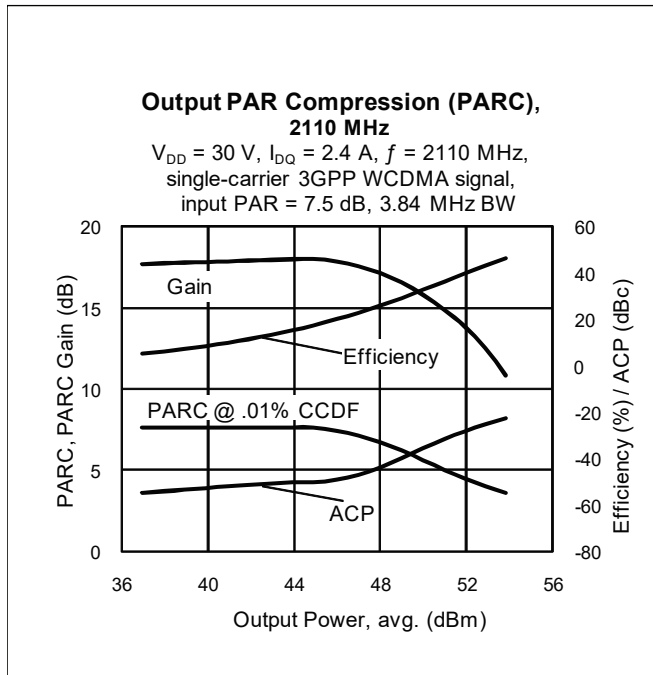

Broadband Circuit Impedance

Frequency MHz	Z Source Ω		Z Load Ω	
	R	jX	R	jX
2080	1.55	-4.57	0.71	-2.91
2090	1.54	-4.52	0.71	-2.89
2100	1.52	-4.48	0.70	-2.86
2110	1.51	-4.44	0.70	-2.84
2120	1.50	-4.40	0.70	-2.81
2130	1.48	-4.36	0.70	-2.79
2140	1.47	-4.32	0.70	-2.77
2150	1.46	-4.28	0.70	-2.74
2160	1.45	-4.24	0.69	-2.72
2170	1.43	-4.20	0.69	-2.70
2180	1.42	-4.17	0.69	-2.67
2190	1.41	-4.13	0.69	-2.65
2200	1.40	-4.09	0.69	-2.63

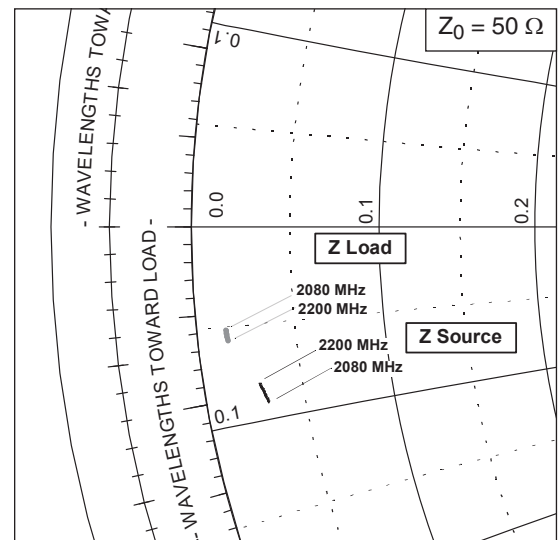
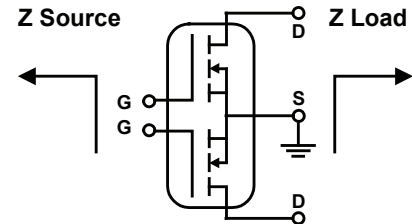

Reference Circuit (cont.)

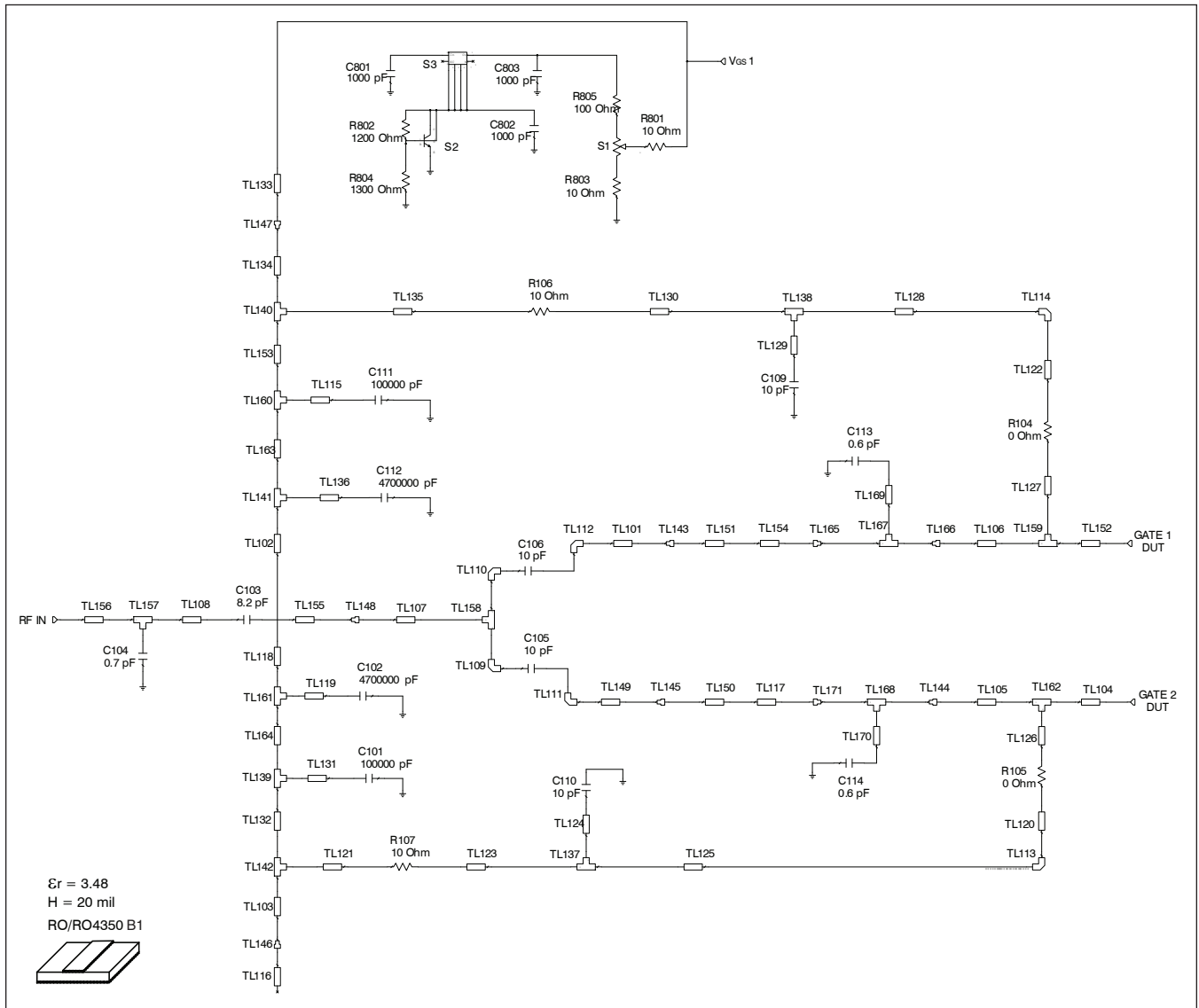

Reference circuit input schematic for $f = 2170 \text{ MHz}$

Reference Circuit (cont.)

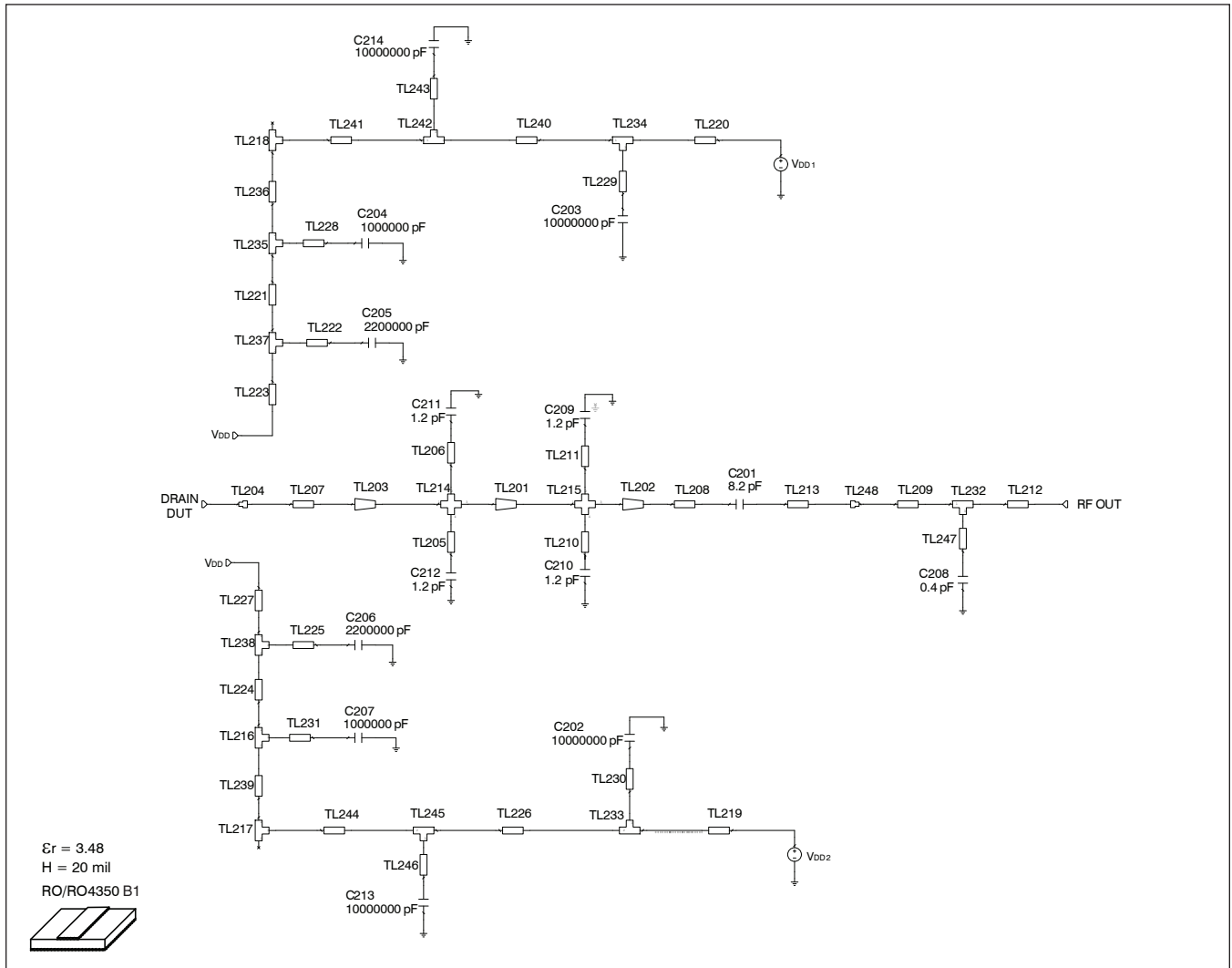

Reference circuit output schematic for $f = 2170 \text{ MHz}$

Reference Circuit (cont.)

Description			
DUT	PTFB213004F	LDMOS Transistor	
PCB	LTN/PTFB213004EF	0.508 mm [.020"] thick, $\epsilon_r = 3.48$	Rogers 4350, 1 oz. copper

Electrical Characteristics at 2170 MHz

Transmission Line	Electrical Characteristics	Dimensions: mm	Dimensions: mils
Input			
TL101	0.004 λ , 51.98 Ω	W1 = 1.087, W2 = 1.087, W3 = 0.813	W1 = 43, W2 = 43, W3 = 32
TL101	0.010 λ , 28.85 Ω	W = 2.540, L = 0.787	W = 100, L = 31
TL102	0.207 λ , 63.89 Ω	W = 0.762, L = 17.526	W = 30, L = 690
TL103	0.006 λ , 63.89 Ω	W = 0.762, L = 0.508	W = 30, L = 20
TL104	0.070 λ , 8.03 Ω	W = 11.430, L = 5.359	W = 450, L = 211
TL105, TL106	0.017 λ , 8.03 Ω	W = 11.430, L = 1.270	W = 450, L = 50
TL107	0.025 λ , 32.60 Ω	W = 2.159, L = 2.032	W = 85, L = 80
TL108	0.015 λ , 49.69 Ω	W = 1.168, L = 1.270	W = 46, L = 50
TL109, TL110, TL111, TL112		W = 2.540	W = 100
TL113, TL114		W = 1.016	W = 40
TL115, TL131	0.000 λ , 41.75 Ω	W = 1.524, L = 0.025	W = 60, L = 1
TL116, TL133	0.016 λ , 34.08 Ω	W = 2.032, L = 1.270	W = 80, L = 50
TL117	0.016 λ , 17.20 Ω	W = 4.826, L = 1.270	W = 190, L = 50
TL118	0.041 λ , 63.89 Ω	W = 0.762, L = 3.480	W = 30, L = 137
TL119, TL136	0.000 λ , 41.75 Ω	W = 1.524, L = 0.025	W = 60, L = 1
TL120, TL122	0.015 λ , 54.17 Ω	W = 1.016, L = 1.262	W = 40, L = 50
TL121, TL135	0.020 λ , 54.17 Ω	W = 1.016, L = 1.651	W = 40, L = 65
TL123, TL130	0.017 λ , 54.17 Ω	W = 1.016, L = 1.397	W = 40, L = 55
TL124, TL129	0.000 λ , 34.08 Ω	W = 2.032, L = 0.025	W = 80, L = 1
TL125, TL128	0.091 λ , 54.17 Ω	W = 1.016, L = 7.620	W = 40, L = 300
TL126, TL127	0.009 λ , 54.17 Ω	W = 1.016, L = 0.762	W = 40, L = 30
TL132	0.018 λ , 63.89 Ω	W = 0.762, L = 1.524	W = 30, L = 60
TL134	0.006 λ , 63.89 Ω	W = 0.762, L = 0.508	W = 30, L = 20
TL137, TL138	0.024 λ , 54.17 Ω	W1 = 1.016, W2 = 1.016, W3 = 2.032	W1 = 40, W2 = 40, W3 = 80
TL139, TL141	0.018 λ , 63.89 Ω	W1 = 0.762, W2 = 0.762, W3 = 1.524	W1 = 30, W2 = 30, W3 = 60
TL140, TL142	0.012 λ , 63.89 Ω	W1 = 0.762, W2 = 0.762, W3 = 1.016	W1 = 30, W2 = 30, W3 = 40
TL143		W1 = 0.003, W2 = 0.005, Offset = 0.000	W1 = 3, W2 = 190, Offset = 10
TL144		W1 = 0.005, W2 = 0.011, Offset = -0.003	W1 = 5, W2 = 450, Offset = -130
TL145		W1 = 0.003, W2 = 0.005, Offset = 0.000	W1 = 3, W2 = 190, Offset = -10
TL146		W1 = 2.032, W2 = 0.762	W1 = 80, W2 = 30
TL147		W1 = 2.540, W2 = 0.762	W1 = 100, W2 = 30
TL148		W1 = 1.168, W2 = 2.159	W1 = 46, W2 = 85
TL149	0.009 λ , 28.85 Ω	W = 2.540, L = 0.762	W = 100, L = 30
TL150, TL151	0.006 λ , 17.20 Ω	W = 4.826, L = 0.508	W = 190, L = 20

table continued on page 10

Reference Circuit (cont.)**Electrical Characteristics at 2170 MHz**

Transmission Line	Electrical Characteristics	Dimensions: mm	Dimensions: mils
Input			
TL152	0.070 λ , 8.03 Ω	W = 11.430, L = 5.359	W = 450, L = 211
TL153	0.018 λ , 63.89 Ω	W = 0.762, L = 1.524	W = 30, L = 60
TL154	0.016 λ , 17.20 Ω	W = 4.826, L = 1.270	W = 190, L = 50
TL155	0.060 λ , 49.69 Ω	W = 1.168, L = 5.022	W = 46, L = 198
TL156	0.002 λ , 49.69 Ω	W = 1.168, L = 0.203	W = 46, L = 8
TL157	0.015 λ , 49.69 Ω	W1 = 1.168, W2 = 1.168, W3 = 1.270	W1 = 46, W2 = 46, W3 = 50
TL158	0.027 λ , 28.85 Ω	W1 = 2.540, W2 = 2.540, W3 = 2.159	W1 = 100, W2 = 100, W3 = 85
TL159, TL162	0.013 λ , 8.03 Ω	W1 = 11.430, W2 = 11.430, W3 = 1.016	W1 = 450, W2 = 450, W3 = 40
TL160, TL161	0.018 λ , 63.89 Ω	W1 = 0.762, W2 = 0.762, W3 = 1.524	W1 = 30, W2 = 30, W3 = 60
TL163, TL164	0.004 λ , 63.89 Ω	W = 0.762, L = 0.330	W = 30, L = 13
TL165, TL171		W1 = 0.011, W2 = 0.003, Offset = 0.005	W1 = 11, W2 = 100, Offset = 200
TL166		W1 = 0.005, W2 = 0.011, Offset = 0.003	W1 = 5, W2 = 450, Offset = 130
TL167		W1 = 0.000, W2 = 0.000, W3 = 0.000	W1 = 0, W2 = 1, W3 = 1
TL168	0.000 λ , 148.22 Ω	W1 = 0.013, W2 = 0.013, W3 = 0.013	W1 = 1, W2 = 1, W3 = 1
TL169	0.000 λ , 102.05 Ω	W = 0.254, L = 0.025	W = 10, L = 1
TL170	0.000 λ , 47.12 Ω	W = 1.270, L = 0.025	W = 50, L = 1

See next page for reference circuit output characteristics

Reference Circuit (cont.)

Electrical Characteristics at 2170 MHz

Transmission Line	Electrical Characteristics	Dimensions: mm	Dimensions: mils
Output			
TL201 (taper)	0.018 λ , 5.40 Ω / 9.59 Ω	W1 = 17.526, W2 = 9.398, L = 1.397	W1 = 690, W2 = 370, L = 55
TL202 (taper)	0.016 λ , 9.59 Ω / 34.72 Ω	W1 = 9.398, W2 = 1.981, L = 1.270	W1 = 370, W2 = 78, L = 50
TL203 (taper)	0.026 λ , 3.67 Ω / 5.40 Ω	W1 = 26.365, W2 = 17.526, L = 1.956	W1 = 1038, W2 = 690, L = 77
TL204		W1 = 25.400, W2 = 26.365	W1 = 1000, W2 = 1038
TL205, TL206, TL210, TL211	0.000 λ , 144.35 Ω	W = 0.025, L = 0.025	W = 1, L = 1
TL207	0.064 λ , 3.67 Ω	W = 26.365, L = 4.801	W = 1038, L = 189
TL208	0.050 λ , 34.72 Ω	W = 1.981, L = 4.115	W = 78, L = 162
TL209	0.028 λ , 47.12 Ω	W = 1.270, L = 2.337	W = 50, L = 92
TL212	0.053 λ , 47.12 Ω	W = 1.270, L = 4.394	W = 50, L = 173
TL213	0.016 λ , 28.85 Ω	W = 2.540, L = 1.270	W = 100, L = 50
TL214		W1 = 17.526, W2 = 0.025, W3 = 17.526, W4 = 0.025	W1 = 690, W2 = 1, W3 = 690, W4 = 1
TL215		W1 = 9.398, W2 = 0.025, W3 = 9.398, W4 = 0.025	W1 = 370, W2 = 1, W3 = 370, W4 = 1
TL216	0.022 λ , 20.93 Ω	W1 = 3.810, W2 = 3.810, W3 = 1.778	W1 = 150, W2 = 150, W3 = 70
TL217, TL218	0.048 λ , 20.93 Ω	W1 = 3.810, W2 = 3.810, W3 = 3.810	W1 = 150, W2 = 150, W3 = 150
TL219, TL220	0.017 λ , 20.93 Ω	W = 3.810, L = 1.372	W = 150, L = 54
TL221	0.008 λ , 20.93 Ω	W = 3.810, L = 0.635	W = 150, L = 25
TL222, TL225, TL228, TL231	0.000 λ , 37.51 Ω	W = 1.778, L = 0.025	W = 70, L = 1
TL223	0.032 λ , 20.93 Ω	W = 3.810, L = 2.540	W = 150, L = 100
TL224	0.008 λ , 20.93 Ω	W = 3.810, L = 0.635	W = 150, L = 25
TL226	0.165 λ , 20.93 Ω	W = 3.810, L = 13.106	W = 150, L = 516
TL227	0.032 λ , 20.93 Ω	W = 3.810, L = 2.540	W = 150, L = 100
TL229, TL230	0.000 λ , 20.93 Ω	W = 3.810, L = 0.025	W = 150, L = 1
TL232	0.024 λ , 47.12 Ω	W1 = 1.270, W2 = 1.270, W3 = 2.032	W1 = 50, W2 = 50, W3 = 80
TL233, TL234	0.048 λ , 20.93 Ω	W1 = 3.810, W2 = 3.810, W3 = 3.810	W1 = 150, W2 = 150, W3 = 150
TL235, TL237, TL238	0.022 λ , 20.93 Ω	W1 = 3.810, W2 = 3.810, W3 = 1.778	W1 = 150, W2 = 150, W3 = 70
TL236, TL239	0.018 λ , 20.93 Ω	W = 3.810, L = 1.397	W = 150, L = 55
TL240	0.165 λ , 20.93 Ω	W = 3.810, L = 13.106	W = 150, L = 516
TL241	0.006 λ , 20.93 Ω	W = 3.810, L = 0.508	W = 150, L = 20
TL242, TL245	0.026 λ , 20.93 Ω	W1 = 3.810, W2 = 3.810, W3 = 2.032	W1 = 150, W2 = 150, W3 = 80
TL243, TL246, TL247	0.000 λ , 34.08 Ω	W = 2.032, L = 0.025	W = 80, L = 1
TL244	0.006 λ , 20.93 Ω	W = 3.810, L = 0.508	W = 150, L = 20
TL248		W1 = 2.540, W2 = 1.270	W1 = 100, W2 = 50



Reference Circuit (cont.)

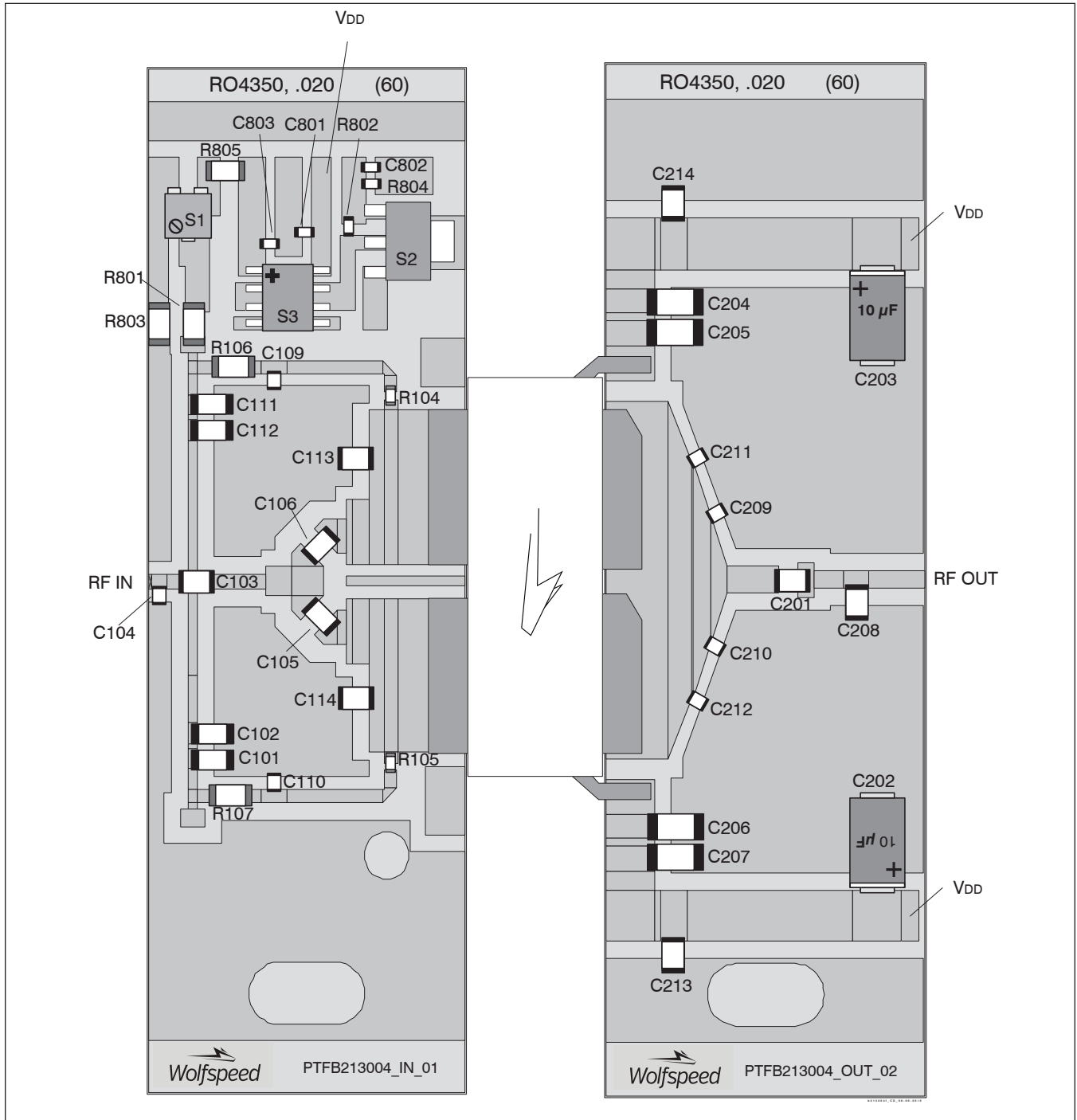

Reference circuit assembly diagram (not to scale)*

*Gerber Files for this circuit available on request

Reference Circuit (cont.)**Circuit Assembly Information**

Component	Description	Suggested Manufacturer	P/N
Input			
C101, C108, C111	Chip capacitor, 0.1 μ F	Digi-Key	PCC104BTR-ND
C102, C112	Chip capacitor, 4.7 μ F	Digi-Key	493-2372-2-ND
C103	Chip capacitor, 8.2 pF	ATC	ATC100B8R2BW500XB
C104	Chip capacitor, 0.7 pF	ATC	ATC100A0R7BW150XB
C105, C106	Chip capacitor, 10 pF	ATC	ATC100B100FW500XB
C107	Capacitor, 10 μ F	Digi-Key	399-1655-2-ND
C109, C110	Chip capacitor, 10 pF	ATC	ATC100A100FW150XB
C113, C114	Chip capacitor, 0.6 pF	ATC	ATC100B0R6BW500XB
C801, C802, C803	Chip capacitor, 1000 pF	Digi-Key	PCC1772CT-ND
R101, R102	Resistor, 0 Ω	Digi-Key	P0.0ECT-ND
R103, R106, R107, R801, R803	Resistor, 10 Ω	Digi-Key	P10ECT-ND
R104, R105	Resistor, 0 Ω	Digi-Key	P0.0GCT-ND
R802	Resistor, 1200 Ω	Digi-Key	P1.2KECT-ND
R804	Resistor, 1300 Ω	Digi-Key	P1.3KGCT-ND
R805	Resistor, 100 Ω	Digi-Key	P100ECT-ND
S1	Potentiometer, 2k Ω	Digi-Key	3224W-202ECT-ND
S2	Transistor	Digi-Key	BCP56
S3	Voltage Regulator	Digi-Key	LM7805
Output			
C201	Chip capacitor, 8.2 pF	ATC	ATC100B8R2BW500XB
C202, C203	Capacitor, 10 μ F	Digi-Key	399-1655-2-ND
C204, C207	Chip capacitor, 1 μ F	Digi-Key	445-1411-2-ND
C205, C206	Chip capacitor, 2.2 μ F	Digi-Key	445-1447-2-ND
C208	Chip capacitor, 0.4 pF	ATC	ATC100B0R4BW500XB
C209, C210, C211, C212	Chip capacitor, 1.2 pF	ATC	ATC100A1R2BW150XB
C213, C214	Capacitor, 10 μ F	Digi-Key	587-1818-2-ND

Pinout Diagram

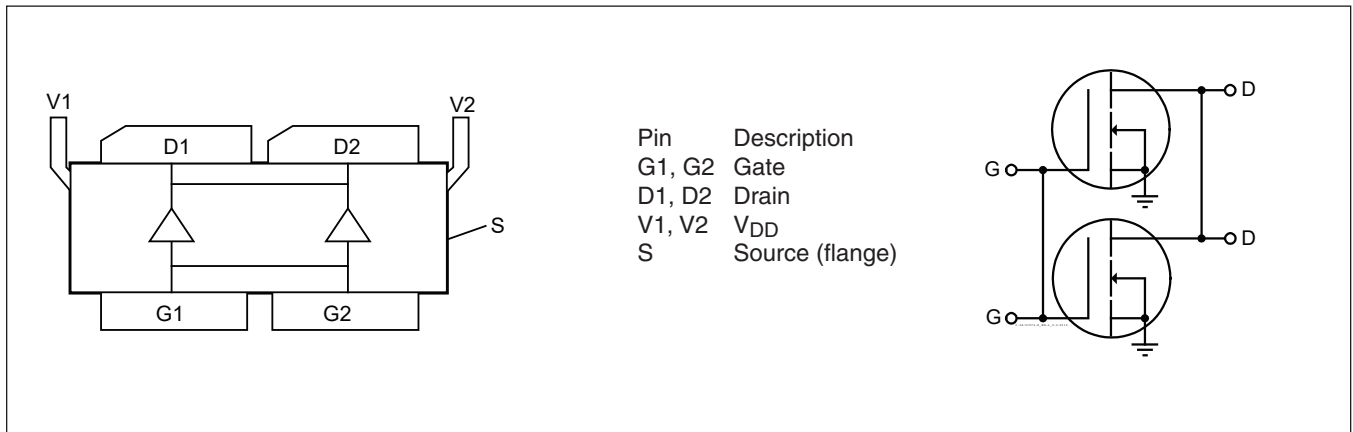

See next page for package outline specifications

Package Outline Specifications

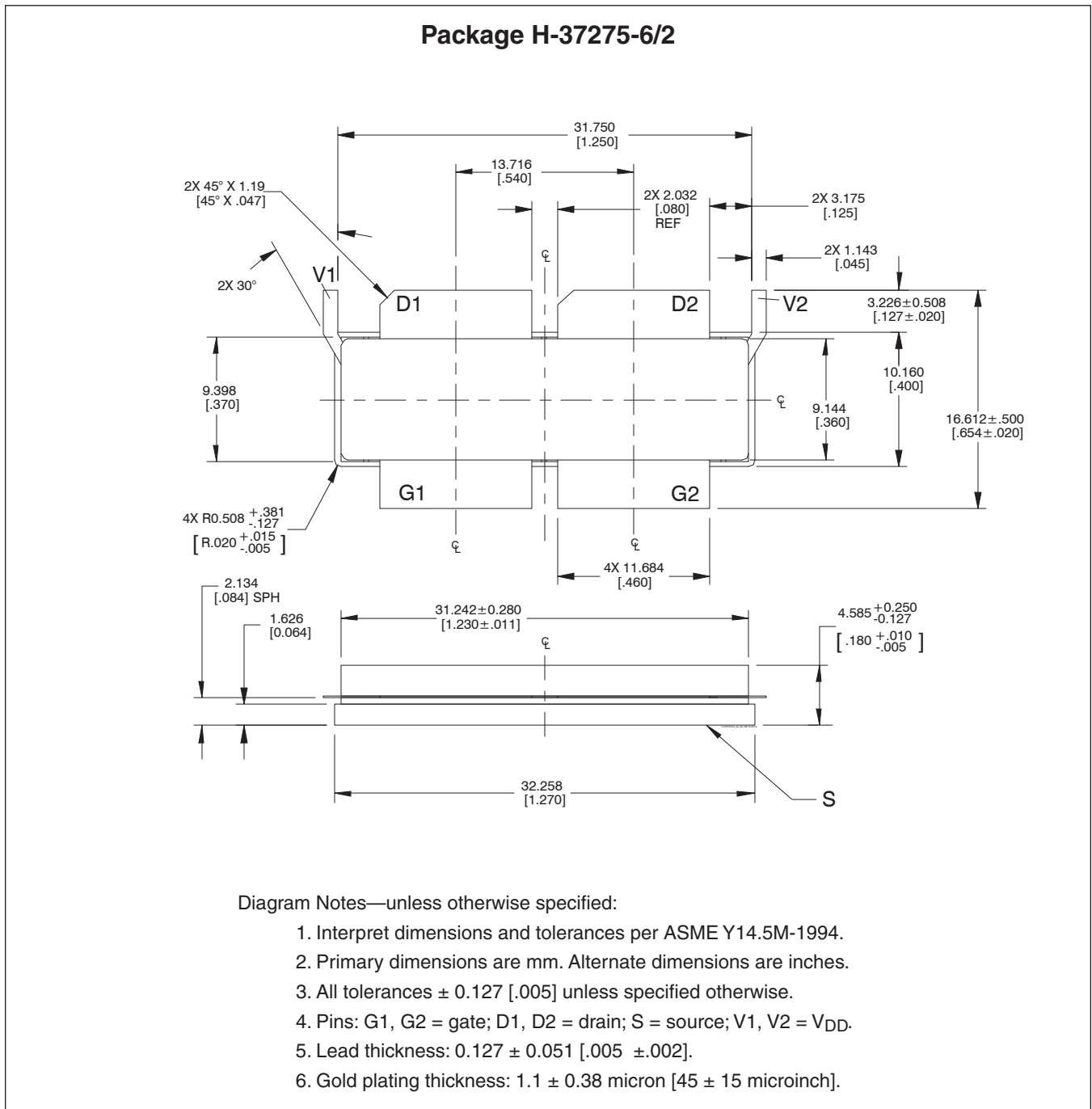

Revision History

Revision	Date	Data Sheet Type	Page	Subjects (major changes at each revision)
05.3	2016-06-15	Production	2	Updated ordering information
06	2018-06-29	Production	All	Converted to Wolfspeed Data Sheet

For more information, please contact:

4600 Silicon Drive
 Durham, North Carolina, USA 27703
www.wolfspeed.com/RF

Sales Contact
RFSales@wolfspeed.com

RF Product Marketing Contact
RFMarketing@wolfspeed.com
 919.407.7816

Notes

Disclaimer

Specifications are subject to change without notice. Cree, Inc. believes the information contained within this data sheet to be accurate and reliable. However, no responsibility is assumed by Cree for any infringement of patents or other rights of third parties which may result from its use. No license is granted by implication or otherwise under any patent or patent rights of Cree. Cree makes no warranty, representation or guarantee regarding the suitability of its products for any particular purpose. "Typical" parameters are the average values expected by Cree in large quantities and are provided for information purposes only. These values can and do vary in different applications and actual performance can vary over time. All operating parameters should be validated by customer's technical experts for each application. Cree products are not designed, intended or authorized for use as components in applications intended for surgical implant into the body or to support or sustain life, in applications in which the failure of the Cree product could result in personal injury or death or in applications for planning, construction, maintenance or direct operation of a nuclear facility.