

DVI_A(M)

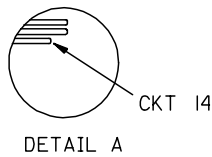

DETAIL A

CXXX
 WEEK NO. FOR YEAR.
 YEAR NO.
 "C" FOR MOLEX CHINA

DETAIL C

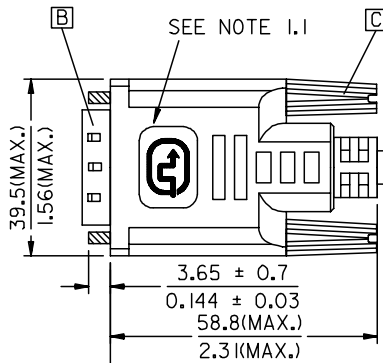

WEEK CODE
 SEE DETAIL C

CXXX

SEE NOTE 1.4

LENGTH(SEE TABLE)

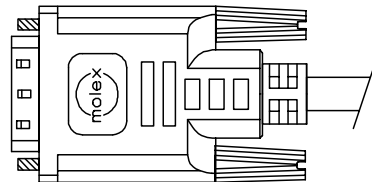

BACK SIDE

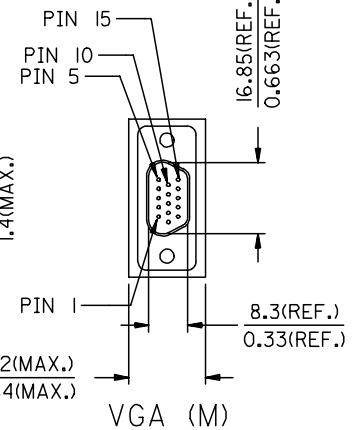
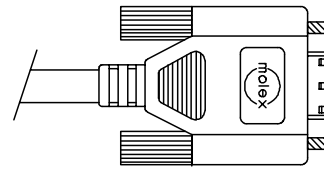

VGA (M)

88741-8321	DVI_A-VGA CABLE ASS'Y 5M PARCHMENT WHT	5000 ± 150 196.9 ± 5.9	PARCHMENT WHITE	887808286
88741-8311	DVI_A-VGA CABLE ASS'Y 3M PARCHMENT WHT	3000 ± 80 118.1 ± 3.1	PARCHMENT WHITE	887808286
88741-8301	DVI_A-VGA CABLE ASS'Y 2M PARCHMENT WHT	2000 ± 60 78.7 ± 2.4	PARCHMENT WHITE	887808286
88741-8320	DVI_A-VGA CABLE ASS'Y 5M BLK	5000 ± 150 196.9 ± 5.9	BLACK	887808277
88741-8310	DVI_A-VGA CABLE ASS'Y 3M BLK	3000 ± 80 118.1 ± 3.1	BLACK	887808277
88741-8300	DVI_A-VGA CABLE ASS'Y 2M BLK	2000 ± 60 78.7 ± 2.4	BLACK	887808277
MX P/N	DESCRIPTION	LENGTH	CABLE COLOR	CABLE P/N

ENTER DESCRIPTION EC NO: DG2006-0186 DRWN:PDAI CHKD: APPR:TKAN	QUALITY SYMBOLS ▽=0 ◻=0	GENERAL TOLERANCES (UNLESS SPECIFIED)		DIMENSION STYLE		SCALE	DESIGN UNITS	THIRD ANGLE PROJECTION		
			mm	INCH	MM/IN		---	METRIC	□	
		4 PLACES	±---	±---	DRAWN BY	DATE	TITLE			
		3 PLACES	±---	±---	PDAI	2006/03/07	DVI_A-VGA CABLE			
	2 PLACES	±---	±---	CHECKED BY	DATE	MOLEX INCORPORATED				
	1 PLACE	±---	±---	ZXDENG	2006/03/07					
	ANGULAR ±---°		APPROVED BY	DATE	MATERIAL NO.		DOCUMENT NO.	SHEET NO.		
	DRAFT WHERE APPLICABLE MUST REMAIN WITHIN DIMENSIONS		BORON	2006/03/07	SEE TABLE		SD-88741-004	1 OF 2		
			THIS DRAWING CONTAINS INFORMATION THAT IS PROPRIETARY TO MOLEX INCORPORATED AND SHOULD NOT BE USED WITHOUT WRITTEN PERMISSION							

NOTE:1. OVERMOLD SPECIFICATION

FOR DVI

1.1 DVI BOOT MOLDED WITH SNOW WHITE PVC RESIN P/N IS 887800076.

1.2 UL94V-0, COLOR: MAD432

1.3 HARDNESS (DUROMETER): SHORE A 90-95

FOR VGA

1.4 VGA MOLDED WITH PVC BLUE RESIN 887800145.

1.4.1 UL94V-0, COLOR: PANTUNE 661C

2. MECHANICAL SPECIFICATION

2.1 CABLE SHOULD STAND THE PULL FORCE 89-111N FOR 30 SECONDS WITH NO VISIBLE TERMINATION DAMAGE.

2.2 CABLE SHOULD PASS THE FLEX TEST IN 100 CYCLES AT EACH OF PLANES, PER EIA 364-41, CONDITION 1.

3. CABLE ELECTRICAL SPECIFICATION

3.1 DIELECTRIC STRENGTH: 300VDC FOR 10ms

3.2 SIGNAL LINE INSULATION RESISTANCE: 20 MEGA Ohms

3.3 COAXIAL LINES CHARACTERISTIC IMPEDANCE: 75±7.5 Ohms @TDR.

4. DVI CONNECTOR SPECIFICATION

4.1 REFER TO PRODUCT SPEC. PS74320-0001.

4.2 CONTACT PLATING: AU FLASH.



5. THIS PRODUCT MUST MEET MX RoHS COMPLIANCE.

6. CONNECTION DIAGRAM

SHIELD	SHIEDL	GROUND
C 5	PIN R6,G7,B8	ANLOG GROUND
C 4	PIN 13	HORIZONTAL SYNC
C 3	PIN 3	ANLOG
C 2	PIN 2	ANLOG
C 1	PIN 1	ANLOG
PIN 15	PIN 5,10	GROUND(+5V & HV SYNC)
PIN 14,16	PIN 9	POWER +5V/HOT PLUG DETECT
PIN 8	PIN 14	VERTICAL SYNC
PIN 7	PIN 12	DDC DATA
PIN 6	PIN 15	DDC CLOCK
DVI_A	VGA	CABLE FUNCTION

7. MATERIAL LIST

ITEM	DESCRIPTION
E	VGA D-SUB CONNECTOR 887899320
D	VGA D-SUB THUMBSCREW 887806026
C	DVI THUMB SCREW 887806005
B	DVI_A G/F CONNECTOR 743230011
A	DVI ANALOG CABLE(SEE TABLE)

ENTER DESCRIPTION EC NO: DG2006-0186 DRWN:PDAI CHKD: APPR:TKAN 2006/03/09 2006/03/09 2006/03/10	QUALITY SYMBOLS  = 0  = 0	GENERAL TOLERANCES (UNLESS SPECIFIED)		DIMENSION STYLE		SCALE	DESIGN UNITS	 THIRD ANGLE PROJECTION	
			mm	INCH	MM/IN		---		METRIC
		4 PLACES	±---	±---	DRAWN BY	DATE	TITLE		
		3 PLACES	±---	±---	PDAI	2006/03/07	DVI_A-VGA CABLE		
2 PLACES	±---	±---	CHECKED BY	DATE					
1 PLACE	±---	±---	ZXDENG	2006/03/07					
ANGULAR ±---°		APPROVED BY		DATE	MOLEX MOLEX INCORPORATED				
DRAFT WHERE APPLICABLE MUST REMAIN WITHIN DIMENSIONS		BORON		2006/03/07	MATERIAL NO. SEE TABLE		DOCUMENT NO. SD-88741-004		
		SIZE		THIS DRAWING CONTAINS INFORMATION THAT IS PROPRIETARY TO MOLEX INCORPORATED AND SHOULD NOT BE USED WITHOUT WRITTEN PERMISSION		SHEET NO. 2 OF 2			